

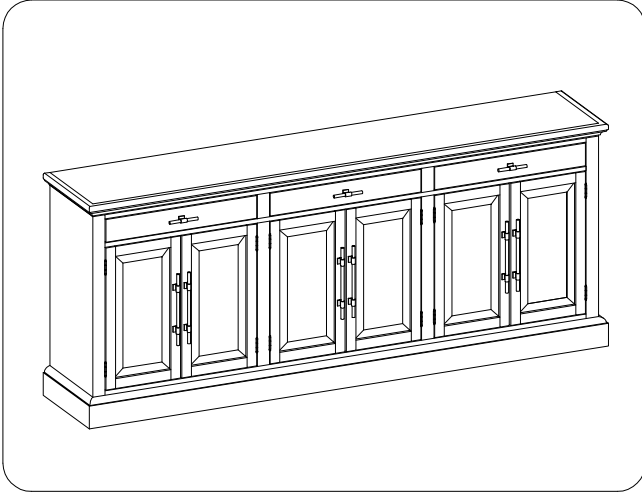

ITEM NO: I311-295-STO/UMB 95" Console w/ 6 Doors

Thank you for purchasing this quality product. Be sure to check all packing material carefully for small parts that may come loose inside the carton during shipment.



TOOLS REQUIRED (NOT PROVIDED)

PHILLIPS SCREWDRIVER

FUNCTIONALITY INSTRUCTION

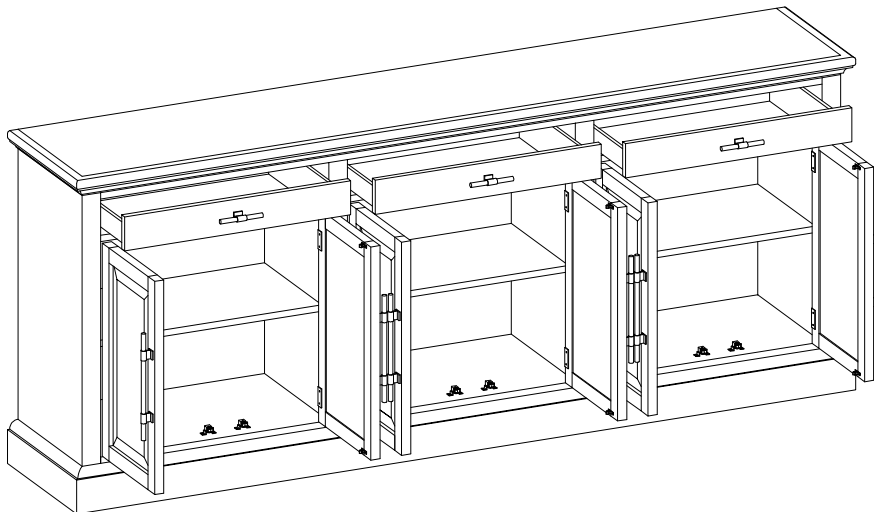

BEFORE USING THIS PRODUCT PLEASE READ, UNDERSTAND, AND FOLLOW THESE INSTRUCTIONS.
Save these instructions for future reference.

FOR INDOOR USE ONLY