

ITEM NO: I540-297 95" Console

Thank you for purchasing this quality product. Be sure to check all packing material carefully for small parts that may come loose inside the carton during shipment.



TOOLS REQUIRED (NOT PROVIDED)
PHILLIPS SCREWDRIVER

FUNCTIONALITY INSTRUCTION

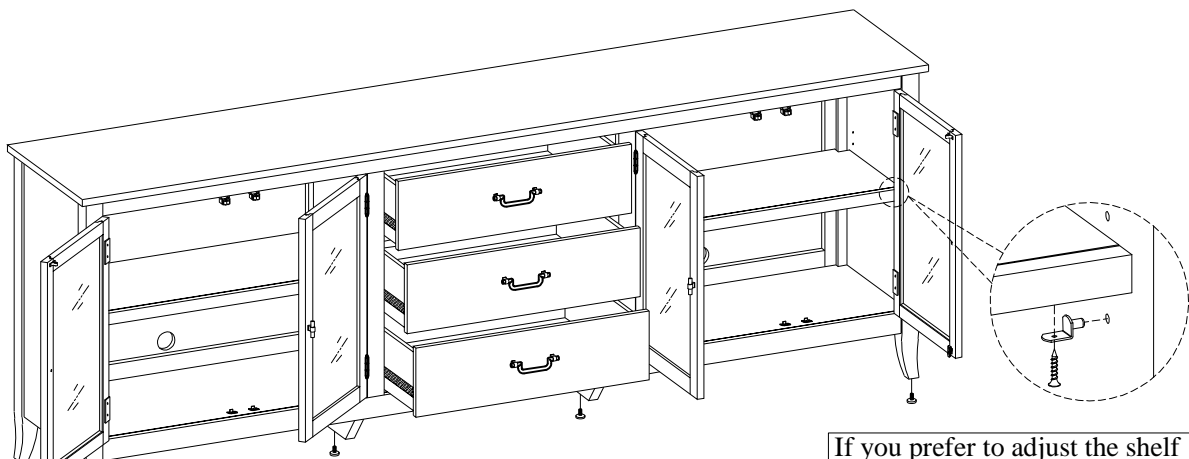

----- Leveler on legs
Adjust the leveler
when necessary

If you prefer to adjust the shelf location, remove the screws and move shelf brackets to the desired location. Then secure the brackets to shelf with screws.

BEFORE USING THIS PRODUCT PLEASE READ, UNDERSTAND, AND FOLLOW THESE INSTRUCTIONS. Save these instructions for future reference.

FOR INDOOR USE ONLY





ITEM NO: I540-297H 95" Hutch





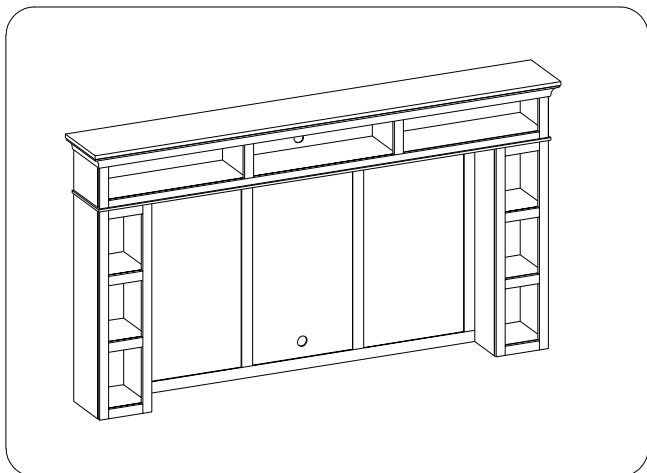

Thank you for purchasing this quality product. Be sure to check all packing material carefully for small parts that may come loose inside the carton during shipment.









UNIT SHOULD BE INSTALLED BY 2 OR MORE PERSONS.



TOOLS REQUIRED (NOT PROVIDED)
PHILLIPS SCREWDRIVER 

HARDWARE LIST:			
No.	Description	Sketch	Quantity
A	Bolt Ø1/4" x 2-1/4"		8 PCS
B	Bolt Ø1/4" x 1-3/8"		20 PCS
C	Lock Washer Ø1/4"		28 PCS
D	Flat Washer Ø1/4" x 3/4"		20 PCS
E	Flat Washer Ø1/4" x 1/2"		8 PCS
F	Allen Wrench 4mm		1 PC
G	Wood Screw #8 x 5/8"		4 PCS

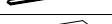
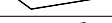
COMPONENTS LIST:			
No.	Description	Sketch	Quantity
1	Top Assembly		1 PC
2	Left Pedestal		1 PC
3	Right Pedestal		1 PC
4	Top End Strip		1 PC
5	Bottom End Strip		1 PC
6	Side Strip		2 PCS
7	Central Strip		2 PCS
8	Side Back Panel		2 PCS
9	Central Back Panel		1 PC

FUNCTIONALITY INSTRUCTION

I540-297H

I540-297

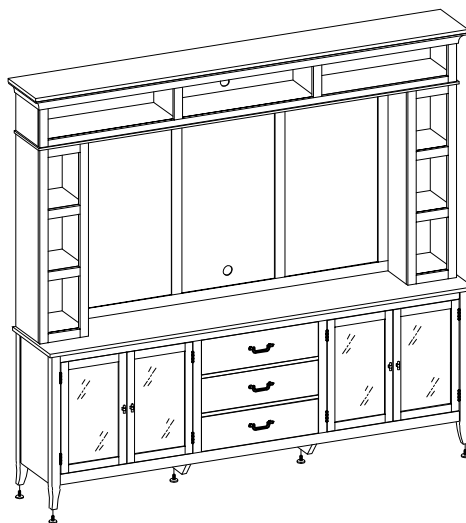

Adjust the leveler when necessary
Leveler on legs

BEFORE USING THIS PRODUCT PLEASE READ, UNDERSTAND, AND FOLLOW THESE INSTRUCTIONS. Save these instructions for future reference.

FOR INDOOR USE ONLY

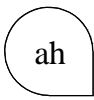

ITEM NO: I540-297H 95" Hutch

STEP 1: Start with the bottom end strip. Attach one side strip and one central strip to bottom end strip using 2 bolts(A), lock washers(C) and flat washers(E). Do not completely tighten bolts to allow some leeway for adjustment in STEP 2. Insert one side back panel into the groove on the side/central strip and slide down firmly. Make sure the bottom of side panel is seated into groove in the bottom end strip. Repeat the same procedure for the rest of strips and side back panel.

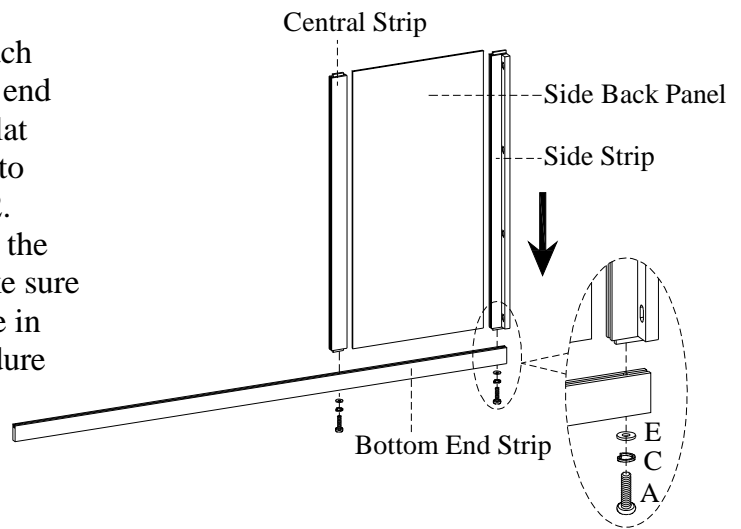

STEP 2: Then insert the central back panel with the cord hole in the bottom. Attach the top end strip to whole back panel using 4 bolts(A), lock washers(C) and flat washers(E). Make sure the back panels' finished side is facing inward. Completely tighten all bolts.

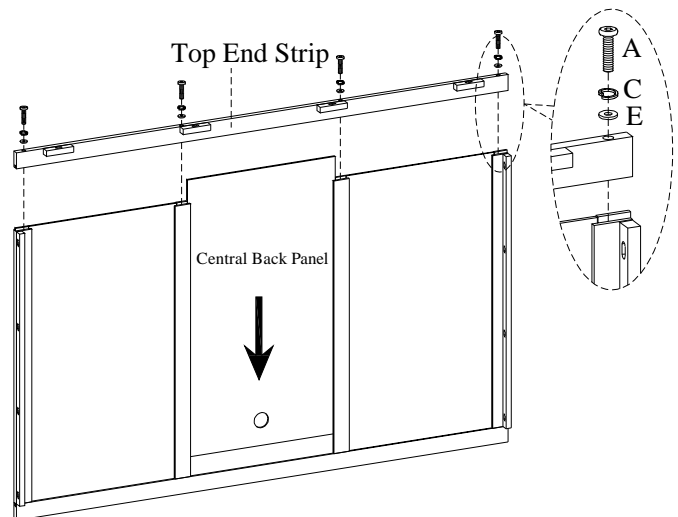

STEP 3: Attach the back panel assembly to the left pedestal and right pedestal using 8 bolts (B), lock washers (C) and flat washers (D). Do not tighten bolts until STEP 4.

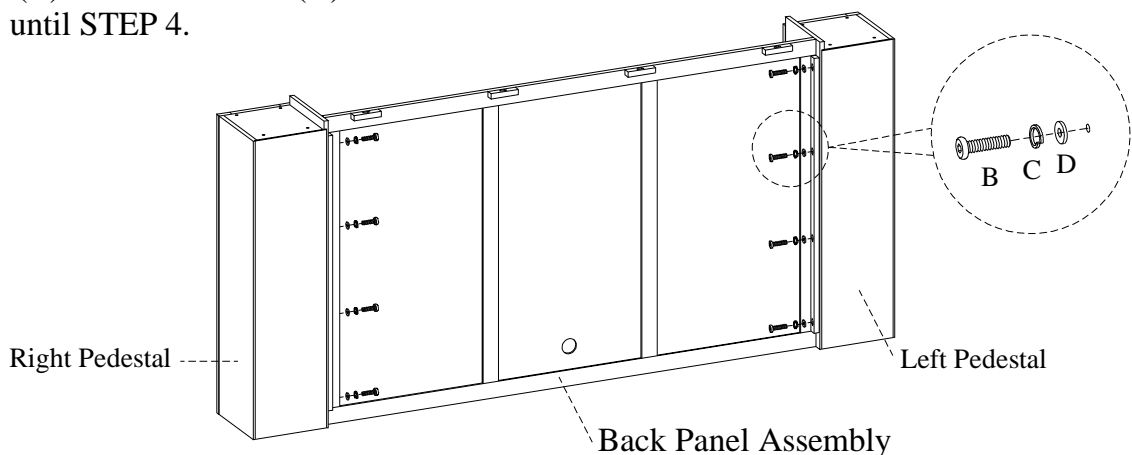

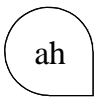

ITEM NO: I540-297H 95" Hutch

STEP 4: Attach the top assembly to left pedestal right pedestal and back panel assembly to using 12 bolts (B), lock washers (C) and flat washers (D). Completely tighten all bolts.

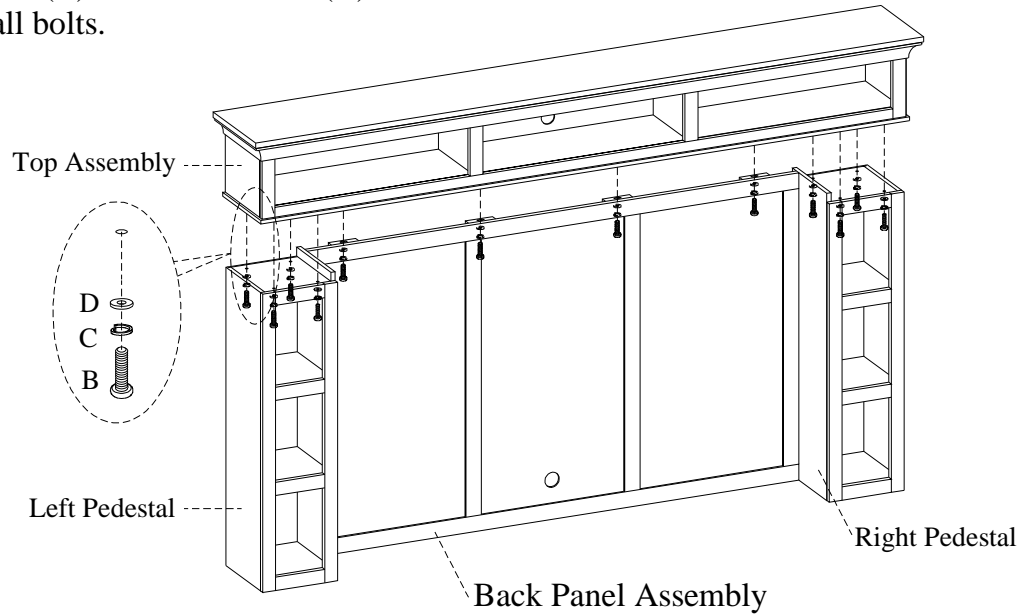

STEP 5: Place the hutch on the console. Take off one screw from each large metal plate on the back of hutch and swing it in an ideal location as shown below. Then re-secure the large metal plate with screws (G) to both hutch and console.

