



ITEM NO: ICB-462-BCH/BLK/EGG/GRY Double Dresser Mirror

Thank you for purchasing this quality product. Be sure to check all packing material carefully for small parts that may come loose inside the carton during shipment.

Option 1: Wall Mount

ICB-462

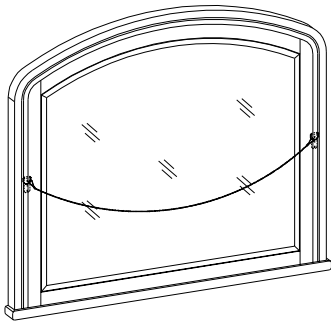

Option 2: Dresser/Chesser Mount

ICB-462

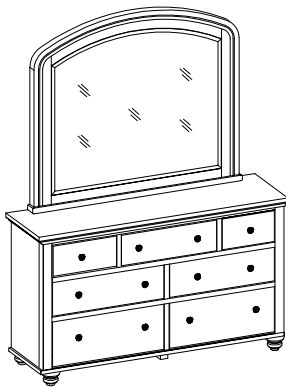



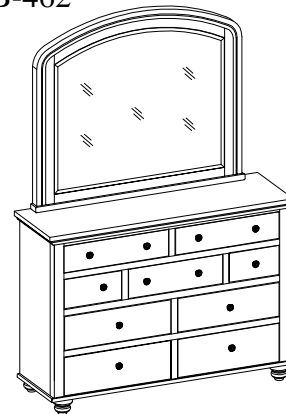

ICB-454

ICB-462





ICB-455

HARDWARE LIST:

No.	Description	Sketch	Quantity
A	Bolt Ø1/4"*1-1/4"		8 PCS
B	Lock Washer Ø1/4"		8 PCS
C	Flat Washer Ø1/4" *3/4"		8 PCS
D	Allen Wrench 4mm		1 PC

COMPONENTS LIST:

No.	Description	Sketch	Quantity
1	Mirror		1 PC
2	Wood Strip		2 PCS

BEFORE USING THIS PRODUCT PLEASE READ, UNDERSTAND, AND FOLLOW THESE INSTRUCTIONS. Save these instructions for future reference.

FOR INDOOR USE ONLY



ITEM NO: ICB-462-WBR/PEP/BLK Double Dresser Mirror

FOR OPTION 1 (Wall Mount)

STEP 1: After attaching nail/hanger to wall, place wire over nail/hanger and slowly lower the mirror into place.

Make sure the wire catches on the nail/hanger.

Note: Ensure the nail/hanger is in a wall stud or wall solid enough to support mirror.

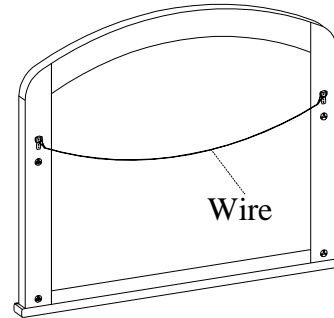

FOR OPTION 2 (Dresser/Chesser Mount)

STEP 1: Attach the wood strips to dresser or chesser the by using 4 bolts(A), lock washers(B), and flat washers(C). Do not tighten bolts completely.

Note: Use inside threaded inserts for item ICB-463 and outside threaded inserts for item ICB-462.

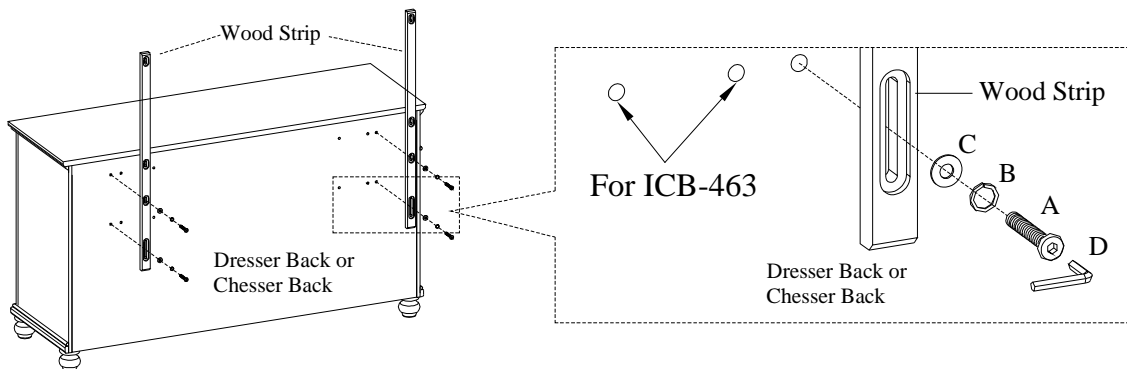

STEP 2: Attach the wood strips to the mirror by using 4 bolts(A), lock washers(B), and flat washers(C). Tighten all bolts on dresser or chesser and mirror with Allen wrench.

