

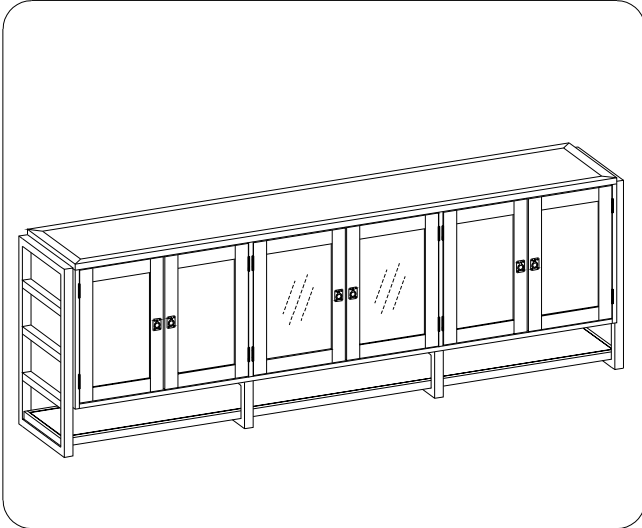

ITEM NO: I215-297 97" Console

Thank you for purchasing this quality product. Be sure to check all packing material carefully for small parts that may come loose inside the carton during shipment.



TOOLS REQUIRED (NOT PROVIDED)
PHILLIPS SCREWDRIVER

FUNCTIONALITY INSTRUCTION

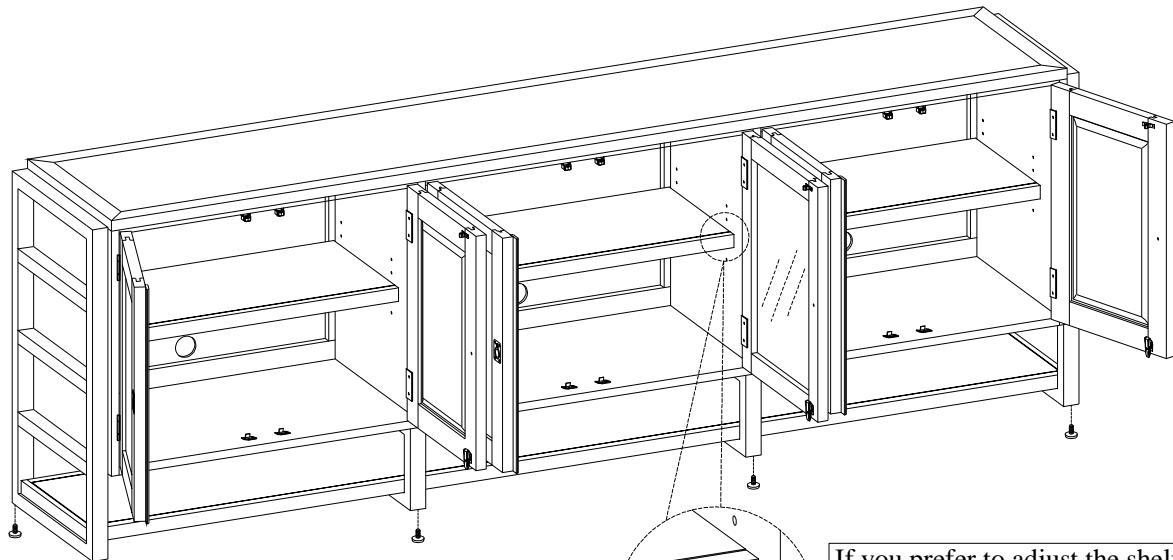

Leveler on bases
Adjust the leveler
when necessary

If you prefer to adjust the shelf location, remove the screws and move shelf brackets to the desired location. Then secure the brackets to shelf with screws.

BEFORE USING THIS PRODUCT PLEASE READ, UNDERSTAND, AND FOLLOW THESE INSTRUCTIONS. Save these instructions for future reference.

FOR INDOOR USE ONLY



ITEM NO: I215-297H 93" Hutch



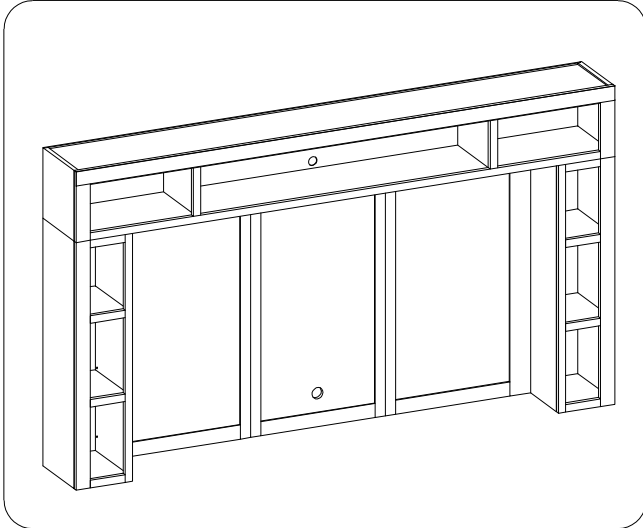



Thank you for purchasing this quality product. Be sure to check all packing material carefully for small parts that may come loose inside the carton during shipment.









TOOLS REQUIRED (NOT PROVIDED)

PHILLIPS SCREWDRIVER 

HARDWARE LIST:

No.	Description	Sketch	Quantity
A	Bolt Ø1/4" x 2"		20 PCS
B	Bolt Ø1/4" x 1"		8 PCS
C	Lock Washer Ø1/4"		28 PCS
D	Flat Washer Ø1/4" x 7/16"		28 PCS
E	Allen Wrench 4mm		1 PC
F	Wood Screw #4 x 5/8"		16 PCS
G	Metal Connect		4 PCS

COMPONENTS LIST:

No.	Description	Sketch	Quantity
1	Top Assembly		1 PC
2	Left Pedestal		1 PC
3	Right Pedestal		1 PC
4	Back Panel (Left)		1 PC
5	Back Panel (Middle)		1 PC
6	Back Panel (Right)		1 PC

FUNCTIONALITY INSTRUCTION

I215-297H

I215-297

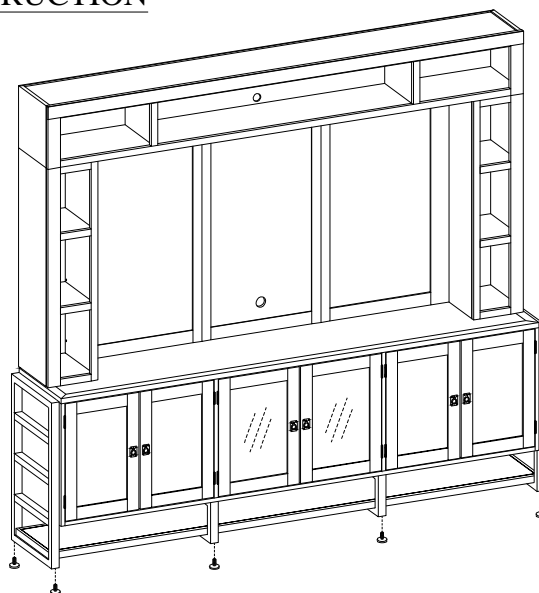

Leveler on bases
Adjust the leveler
when necessary

BEFORE USING THIS PRODUCT PLEASE READ, UNDERSTAND, AND FOLLOW THESE INSTRUCTIONS.
Save these instructions for future reference.

FOR INDOOR USE ONLY

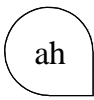

ITEM NO: I215-297H 93" Hutch

STEP 1: Attach the back panel (left & right) to the back panel (middle) using 6 bolts (A), lock washers (C) and flat washers (D) as shown below. Do not completely tighten bolts.

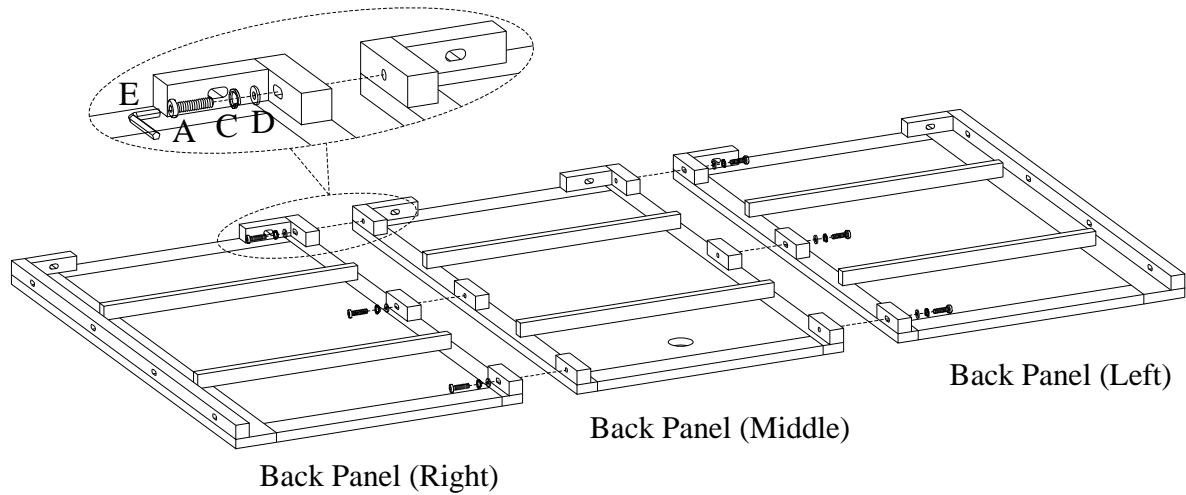

STEP 2: Attach the left pedestal and right pedestal to the top assembly using 8 bolts (B), lock washers (C) and flat washers (D). Do not tighten bolts until STEP 3.

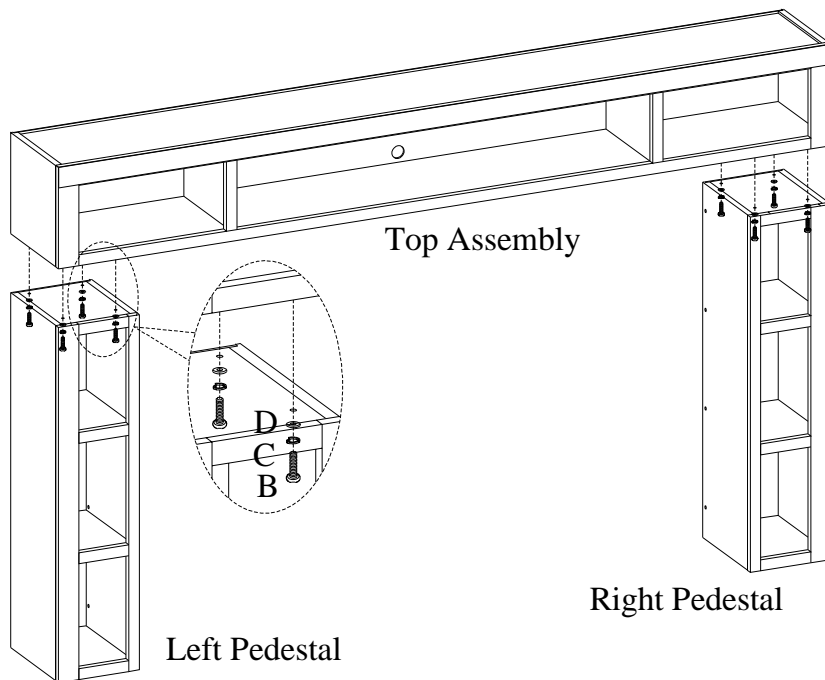

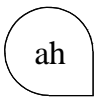

ITEM NO: I215-297H 93" Hutch

STEP 3: Attach the back panel assembly to the left pedestal, right pedestal and top assembly using 14 bolts (A), lock washers (C) and flat washers (D). Completely tighten all bolts.

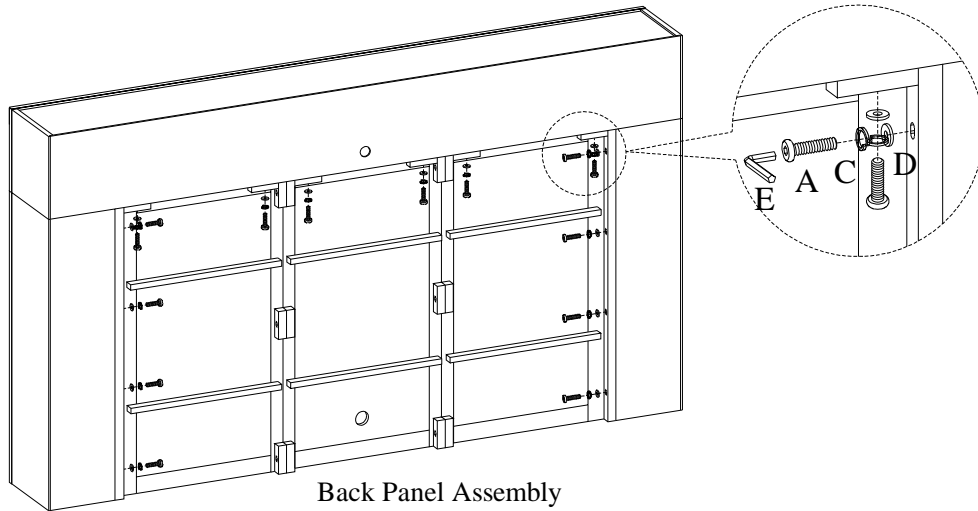

Back Panel Assembly

STEP 4: Position the hutch on the console. Attach the metal connects(G) to the back of hutch with wood screws(F) as shown below.

